

## Key Selection Attributes

- Unique profile provides a refined alternative to a traditional blunt 90-degree vertical trims
- Two profiles available:
  - **AXIOM-Knife Edge** for traditional acoustical lay-in and tegular panels, as well as drywall
  - **AXIOM-Knife Edge for Vector** is specifically made to work with the unique Vector edge
- Extruded aluminum trim provides more crisp edge detailing compared to conventional roll-formed steel systems
- Compatible with Armstrong exposed suspension systems and Drywall Grid Systems
- Colors coordinate with Armstrong ceiling and grid systems; custom colors available
- Standard 90° factory bonded corners
- Factory corners available in configurations between 60° and 135° upon request

### Factory Bonded corners

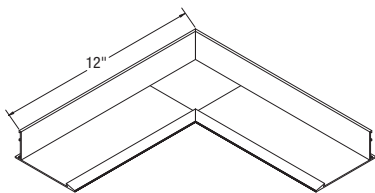

AXIOM-Knife Edge  
Factory Bonded Inside Corner

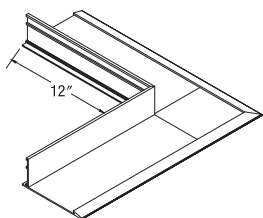

AXIOM-Knife Edge  
Factory Bonded Outside Corner



The narrow Knife Edge profile accentuates the weightless appearance of floating ceiling clouds.



AXIOM-Knife Edge profile is made from extruded aluminum and offers precise detailing and quality.

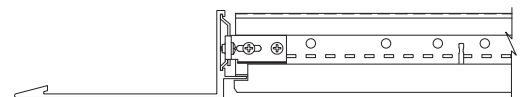

Axiom-Knife Edge for Vector with Vector panel

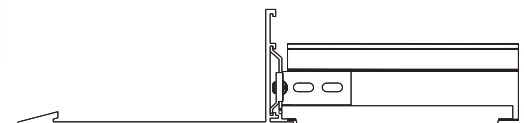

Axiom-Knife Edge with Tegular panel

# AXIOM®— Knife Edge®

Recycled Content:

**50%**

## Trim

### Physical Data

#### Material

Trim Channel: Extruded aluminum, alloy 6063  
 Hanging Clip: Commercial quality aluminum  
 T-Bar Connector Clip: Commercial quality aluminum  
 Splice Plate: Galvanized steel

#### Surface Finish

Factory-applied baked polyester paint finish

#### Cross Tee / Main Beam Interface

Flush fit

#### End detail

Splice with set screws

#### Warranty

10-year limited warranty

### Visual Selection

ITEM NUMBER	DESCRIPTION	DIMENSIONS
<b>AXIOM - Knife Edge</b>		
AXKE2STR	10' Straight	120 x 6-3/16 x 2-1/2"
AXKE90IC	Inside 90° Corner	12 x 6-3/16 x 2-1/2"
AXKE90OC	Outside 90° Corner	12 x 6-3/16 x 2-1/2"
<b>AXIOM - Knife Edge for Vector</b>		
AXKEVE2STR	10' Vector - Straight	120 x 5-9/16 x 2-5/16"
AXKEVE90IC	Inside 90° Corner	12 x 5-9/16 x 2-5/16"
AXKEVE90OC	Outside 90° Corner	12 x 5-9/16 x 2-5/16"
<b>Accessories</b>		
AX2HGC	Hanging Clip	—
AXTBC	T-Bar Connector Clip	—
AX-V-TBC	T-Bar Connector Clip	—
AX4SPLICEB	Splice Plate	—
AXKEALIGN	Alignment Clip	—
AXDWT	10' Drywall Trim	120 x 1-3/4"

### Color Selection

#### STANDARD FINISHES

- WH - White\*\*\*
- CR - Cream
- HA - Haze
- CM - Camel
- PL - Platinum
- BL - Tech Black
- SA - Silver Satin
- BB - Bright Brushed\*
- SG - Silver Grey
- MY - Gun Metal Grey
- PW - Pewter\*\*
- BZ - Bronze\*\*
- SL - Silver\*\*
- CP - Copper\*\*
- WK - Wolf\*\*

- VA - Vanilla\*\*
- ST - Slate\*\*

#### NEW POWDER-COATED FINISHES

- CB - Carbon
- BC - Burnished Copper
- CT - Copper Black Texture
- FR - Forged Iron
- GR - Graphite
- MC - Mica
- NK - Nickel
- PR - Pewter Luster
- SV - Silver Slate
- SR - Steel Luster
- TC - Textured Carbon

**NOTE:** Items AXHGC, AX2HGC, AXSPLICE, AX4SPLICEB, AXTBC, AXPHANG58, AXPHANG118 are available in unpainted only.

\*\* "S" Service items available only as special order  
 \*\*\* Use White for field-painted options.

### Details

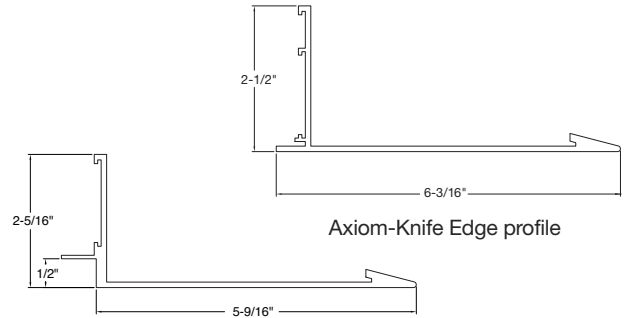

Axiom-Knife Edge for Vector profile

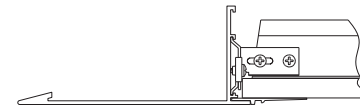

Axiom-Knife Edge with drywall (Use with AX-V-TBC and AXDWT)

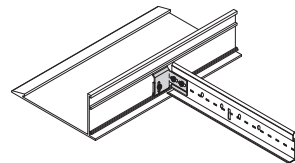

T-Bar Connector Clip (AXTBC)

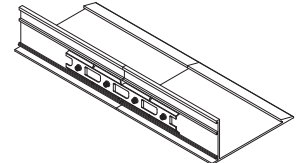

Splice Plate (AX4SPLICEB)

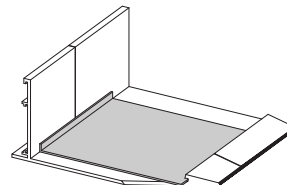

Alignment Clip (AXKEALIGN)



Axiom-Knife Edge with AX2HGC for single panel installation

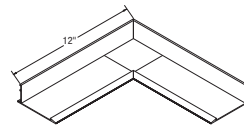

AXIOM-Knife Edge Factory Bonded Inside Corner

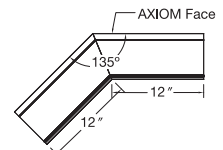

135° Corner

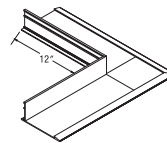

AXIOM-Knife Edge Factory Bonded Outside Corner

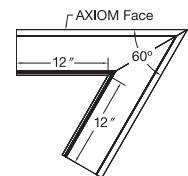

60° Corner